



Mahmi

for water solutions & greenhouse

Mahmi Profile

2024

RO Systems

From 100CBM/D to 2000 CBM/D

Pumps

Exclusive agents of CNP Pumps

Greenhouses

Cooling and Net Greenhouse



 +974 7750 7722

 +974 4450 7722

 info@mahmi.net

 <https://www.facebook.com/MahmiGlobal>

 <https://www.instagram.com/mahmiglobal>

 www.mahmi.net

 Al Zubarah Petrol Station - zone 76 - Street 253, Building 4199
North Road Rawdat Al Faras - Qatar

عن الشركة :

لقد تم تأسيس شركة محمي بناء على خبرات تراكمية لمؤسسيها في مجال تصميم وتصنيع البيوت الزراعية المحمية، ومحطات تحلية، ومعالجة المياه، ومستلزماتها.

وقد كان على رأس أولوياتها ان تكون قادرة على توريد المنتجات والخدمات التي تحقق أفضل المواصفات في هذا المجال ومنذ التأسيس كانت رؤيتنا وهدفنا هي تقديم الخدمات التي تلبي متطلبات المزارعين والمهتمين بالزراعة بأفضل الأسعار وأعلى المواصفات.

نحن نقوم بتصميم وتصنيع وتوريد محطات معالجة وتحلية المياه ونقوم بتصميم وتصنيع وتوريد البيوت الزراعية الشبكية والمبردة ذات التكنولوجيا العالية كما نقوم بتصميم وتوريد أنظمة التسميد والري وأنظمة التحكم بالطقس

ونتعاون مع كبريات الشركات العالمية في مجال البيوت الزراعية المبردة ومستلزماتها بحيث نقدم جميع الحلول في هذا المجال فنحن نختار أفضل المواد الخام لمشاريعنا ودائما نواكب التطورات التكنولوجية في مجال البيوت الزراعية وأنظمة الزراعة المائية

وشركتنا متخصصة في تصميم البيوت الزراعية ونتاج مستلزماتها والتي تصنع منتجاتها وفقا للمواصفات والمعايير الأوروبية المطبقة في أفضل المصانع عالمياً وبأسعار معقولة لتوفير منتجات عالية القيمة

كما ان شركتنا تعتبر مورد رئيسي في السوق القطرية ومنطقة الخليج وشمال افريقيا حيث نقوم بتوريد العديد من المواد ولوازم البيوت الزراعية وأنظمة الزراعة المائية للكثير من المزارع والشركات التي تنشط في مجال الخدمات الزراعية.

About Us :

MAHMI-Qatar was established with the accumulative experiences of its founders in the field of designing and manufacturing greenhouses and Water treatment plants and their equipment,.

And it was MAHMI-Qatar's top priority to be able to supply products and services that can achieve the best specifications in the field, and since its establishment, our vision and goal was to provide services that meet the requirements of both the farmers and those interested in agriculture, at the best prices and the highest specifications.

We design, manufacture, and supply water treatment and desalination plants and we designed, manufactured, and supplied high-tech cooled greenhouses to the area we also design and supply fertilization, irrigation, and environmental control systems.

We cooperated with major international companies in the field of cooled greenhouses and their equipment, so that we could provide all the solutions and services in this field.

We choose the best raw materials for our projects, and we always keep pace with the latest technological developments in the field of greenhouses and hydroponic farming.

Our company specializes in designing and producing greenhouses and agricultural equipment according to European standards and specifications, in the best factories in the world at a suitable price to provide high-value products.

Mahmi Agricultural is one of the major suppliers in the Qatari market, the Gulf region, and North Africa, where we supply materials and necessities of greenhouses and hydroponic systems to many farms and companies that are active in the field of agricultural services.





منتجاتنا وخدماتنا تشمل :

- 1- تصميم وتصنيع وتوريد وصيانة محطات معالجة المياه وجميع مستلزماتها
- 2- تصميم وتصنيع وتركيب الصوب الزراعية بكافة أنواعها وجميع مستلزمات الصالات المبردة والبيوت الشبكية وصلالات المشاتل
- 3- الواح التبريد سماكة 10 و 15 سم وكافة مستلزماته
- 4- جميع أنظمة الزراعة المائية ومستلزماتها
- 5- الواح بولي كربونات مزدوج الجدار (6-8-10) مم
- 6- رقائق البولي ايثيلين 200 ميكرون ثلاث طبقات
- 7- شبك مانع الحشرات وشبك التظليل
- 8- مراوح التبريد الخاصة بالبيوت الزراعية بكافة أنواعها ومقاساتها
- 9- أنظمة التحكم بالبيوت الزراعية وأنظمة التسميد وأنظمة التحكم بالطقس
- 10- اعداد دراسات الجدوى والدراسات الفنية للمشاريع الزراعية
- 11- لوحات التحكم الكهربائية للبيوت الزراعية.

Our Products and Services

- 1- Design, manufacture, supply, and maintenance of water treatment plants and all their accessories.
- 2- Designing, manufacturing, and installing greenhouses of all kinds and all their Requirements (cooling and net greenhouses).
- 3- Cooling panels 10 and 15 cm thickness and all their accessories.
- 4- All hydroponic farming systems and their accessories.
- 5- Double wall polycarbonate sheets (6-8-10)mm.
- 6- 200-micron polyethylene sheets, 3 layered.
- 7- Insect nets and shading nets.
- 8- Cooling fans for greenhouses of all types and sizes.
- 9- Greenhouse control panels, fertilization, and environmental control systems.
- 10- Feasibility studies and technical studies for agricultural projects.
- 11- Electrical control panels for greenhouses and water treatment plants



تصميم وتصنيع وتوريد ،صيانة محطات معالجة وتحلية المياه وجميع مستلزماتها

Specialized RO Water Treatment Manufacturing & Accessories

Mahmi is an Authorized Distributor for Filmtec Membrane



تصميم وتصنيع وتوريد ،صيانة محطات معالجة وتحلية المياه وجميع مستلزماتها

RO System Plants & All their Needs



Assembly, Installation, Maintenance & Spare Parts



تصميم وتصنيع وتوريد ،صيانة محطات معالجة وتحلية المياه وجميع مستلزماتها

RO System Plants & All their Needs



تصميم وتصنيع وتوريد، صيانة محطات معالجة وتحلية المياه وجميع مستلزماتها

RO System Plants & All their Needs



جميع أدوات واكسسوارات محطات التحلية
RO water treatment Accessories

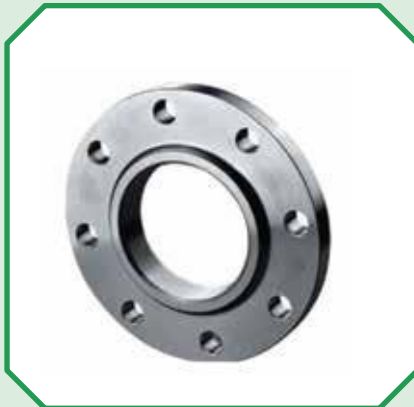

جميع أدوات واكسسوارات محطات التحلية
RO water treatment Accessories

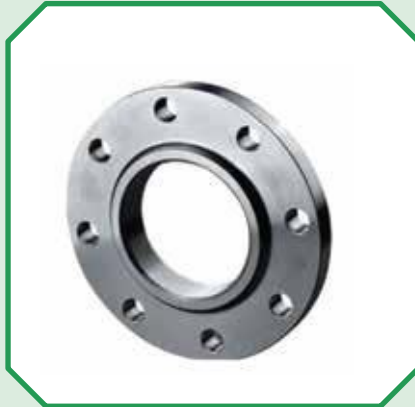
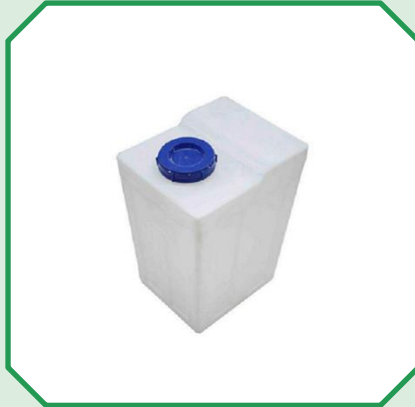



مستلزمات محطات معالجة المياه واكسسوارات ستانلس 316
RO water treatment Accessories & Stainless Steel 316 Fittings

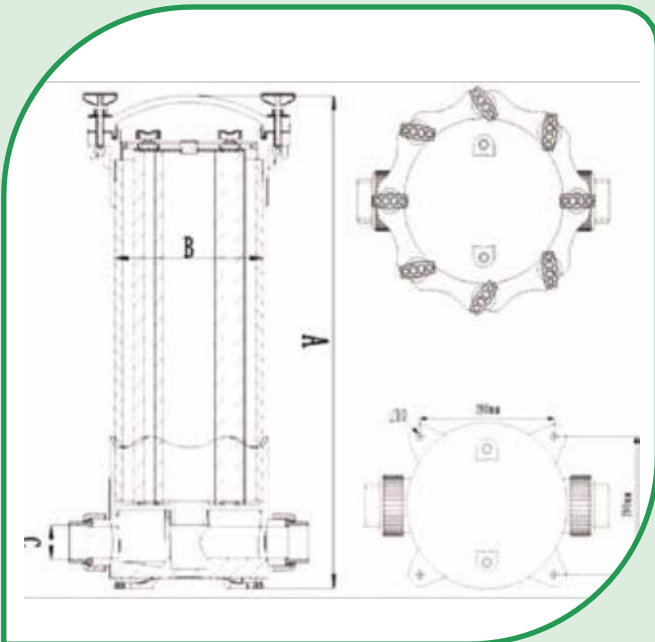



**Mahmi is Exclusive agents of
CNP Pumps in Qatar**



Water is vital for all known forms of life. As the population of the world continues to grow, so does the need for advanced, quality systems of water treatment, irrigation, drainage, and sewage treatment. Industrial growth, so vital to economic stability all over the world, must also embrace responsible, safe, efficient waste disposal methods in order to comply with regulatory agencies and protect the environment in which we live from water and air pollution. CNP has helped many companies attain this goal through decades of experience, incorporating sophisticated planning, engineering, and other support services to pumping stations around the world. Innovative fluid handling solutions that enhance reliability while lowering energy consumption and maintenance costs, reduce carbon emissions, and provide value are what CNP has built its reputation on.

Pumping Water Pumping Honor
www.cnppump.com

**Don't forget to visit www.cnppump.com
for more info about CNP and its products**





**Mahmi is Exclusive agents of
CNP Pumps in Qatar**



**Don't forget to visit www.cnppump.com
for more info about CNP and its products**





**Mahmi is Exclusive agents of
CNP Pumps in Qatar**



**Don't forget to visit www.cnppump.com
for more info about CNP and its products**



شركة محمي قطر تقوم بتصميم وتصنيع وتركيب الصوب الزراعية المبردة
بكافة مقاساتها وحسب متطلبات الزبون

Cooled Greenhouse Designing as Per Customer Request



شركة محمي قطر تقوم بتصميم وتصنيع وتركيب الصوب الزراعية المبردة
بكافة مقاساتها وحسب متطلبات الزبون

Specialized Engineers & Workers in Greenhouse assembly



شركة محمي قطر تقوم بتصميم وتصنيع وتركيب الصوب الزراعية
الشبكية بكافة مقاساتها وحسب متطلبات الزبون

Net Greenhouse Designing as Per Customer Request



متخصصون في تصميم وتوريد وتركيب جميع أنواع أنظمة
الزراعة المائية ومستلزماتها

Specialized Hydroponic System Designing





شركتنا الوكيل الحصري لألواح التبريد ذات الجودة العالية
والخاصة بالبيوت الزراعية

Mahmi Agents For High Quality Cooling Panel Manufacturing



شركتنا الوكيل الحصري لألواح التبريد ذات الجودة العالية
والخاصة بالبيوت الزراعية

Mahmi Agents For High Quality Cooling Panel Manufacturing

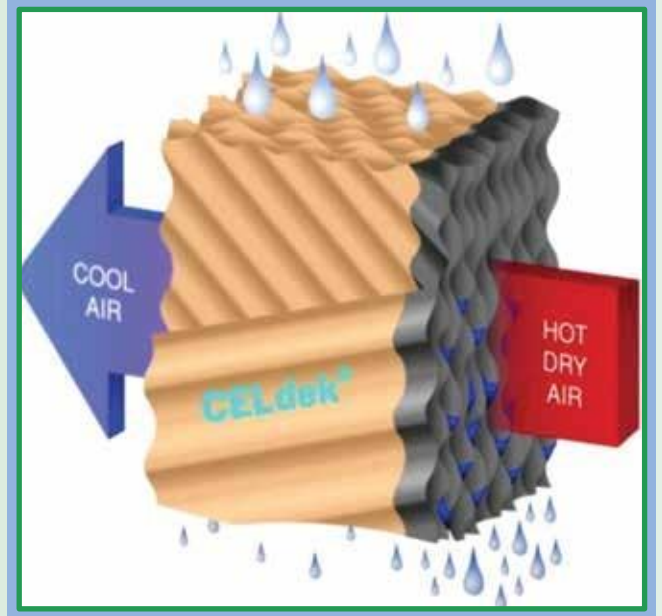
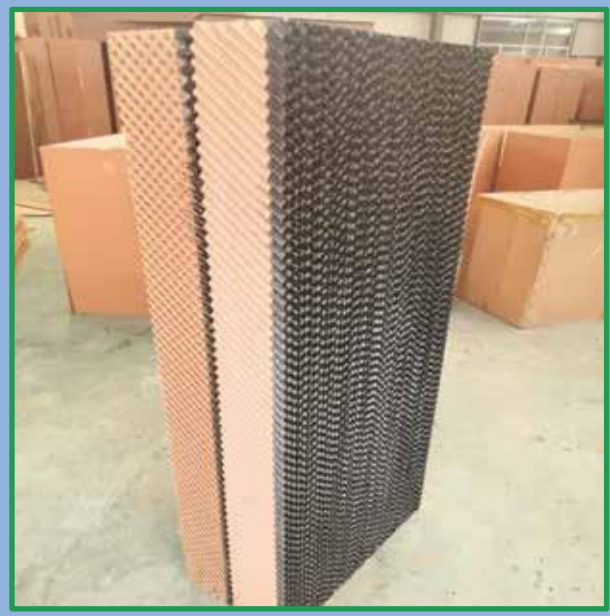

MAHMI COOLING PAD

Black cooling pad Green cooling pad Brown cooling pad

Aluminum alloy frame Fan

[Performance characteristics] :

- Adopting imported European fiber paper, our pad exhibits high absorbability and water resistance. It uses anti-mildew and moth-preventive material to ensure long life service.
- Using special crossing linking technology and a large evaporation area, cooling efficiency is increased to as high as 80%.
- Our cooling pad involves active surface agents which absorb water naturally, allowing for rapid penetration and lasting effectiveness. A drop of water can diffuse in 4-5 seconds. Limit of water absorption: 60-70 mm/ 5 minutes, 200mm/1.5 hours – consistent with international standards.
- Our cooling pad does not contain phenol, which is irritant to the skin. It is harmless to humans and animals and is free of poisons.
- Available colors: brown and green coats.

Transverse water cooling system

Longitudinal water cooling system

[Specifications] :

Height Width Thickness

▲ Full height ▲ Across angle ▲ Across angle ▲

	Model 1000	Model 1200	Model 1500
H (mm)	100	120	150
W (mm)	1000	1200	1500
T (mm)	18	18	18
▲	0	45	45
▲	45	0	45

[Application examples]

[Installation diagram]

[Cooling Pad Production Line]



شركتنا الوكيل الحصري لألواح التبريد ذات الجودة العالية
والخاصة بالبيوت الزراعية

Mahmi Agents For High Quality Cooling Panel Manufacturing



①



②

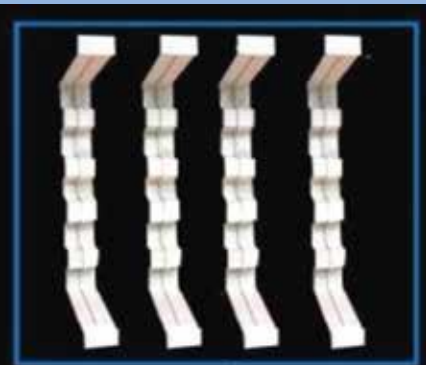

③



④

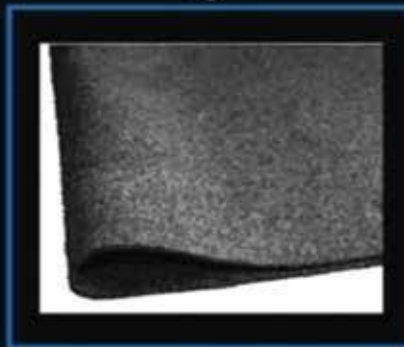

⑤

① Plug the positive

② Plug the back

③ Joint

④ warping preventing

⑤ Geotextile



متخصصون في تصميم وتوريد وتركيب جميع أنواع أنظمة الزراعة المائية
ومستلزماتها ونقوم بتوريد أكياس الكوكو بيت ماركة محمي السويدية
Mahmi Cocopeat & Accessories



Gutter 6,2 x 23

- Polypropylene 0,7 mm
- Extended Width: 35,4 cm
- Weight: 640 gr/m²

Mahmi Agricultural
Tele: +974 77507722 - www.mahmi.net

Eco Spacer

- Polypropylene
- Weight: 270 g/m

Mahmi Agricultural
Tele: +974 77507722 - www.mahmi.net

Clip without ring

Clip-E Ø16

Clip Ø25

- Polypropylene
- Piece Weight: 3 g.
- For fixing the gutter, the spacer and the drip pipe.

Mahmi Agricultural
Tele: +974 77507722 - www.mahmi.net

Out-Flow

- Polypropylene
- Piece Weight: 60 g.
- Exit Diameter: 26 mm.

Mahmi Agricultural
Tele: +974 77507722 - www.mahmi.net



موزعون لألواح البولي كربونات التي تصنع حسب المواصفات والمقاييس الأوروبية وقد اثبتت منتجاتها مقاومة عالية لدرجات الحرارة والرطوبة العالية

Heat & Humidity Resistant Polycarbonate Sheets According to European Standards

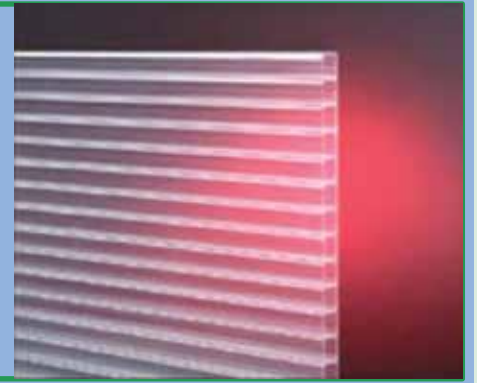

Mahmi Multiwall Polycarbonate Sheet combines the characteristic strength of polycarbonate with insulation. This yields a strong, insulating, lightweight, attractive sheet for varied roofing, cladding, and glazing. **Mahmi** Multiwall Polycarbonate Sheet is used in markets as diverse as construction, agriculture, industry, DIY, and advertising.

Product Features

- High thermal insulation
- Light weight and impact resistant
- High light transmission
- Weather and UV resistance
- Easy to handle and install
- High fire performance rating

Applications

- Architectural roofing and glazing
- Skylights and sidelights
- Displays, signage and decorations
- Industrial roofing and glazing, DIY
- Covered swimming pools
- Agricultural greenhouses

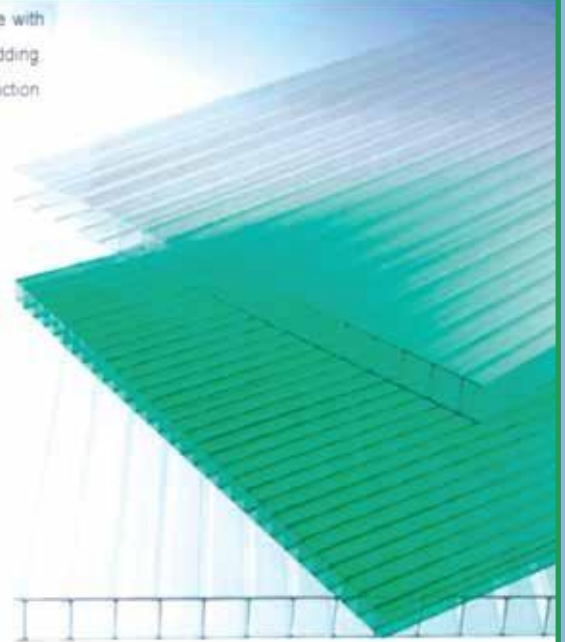

MAHMI POLYCA

REGONATE ANTI-DRIP SHEET PROVIDED AN OPTIMAL CULTIVATION ENVIRONMENT

BY COMBINING HIGH LIGHT TRANSMISSION, EXCELLENT WEATHER RESISTANCE AND A SPECIAL ANTI-DRIP FEATURE.

THE CELLULAR MULTI-LAYER STRUCTURE REDUCES HEATING COSTS IN WINTER WHILE MINIMIZING EXCESSIVE HEAT

IN SUMMER AND A SPECIAL COATING ON THE BOTTOM SIDE ELIMINATES CONDENSATION DRIPPING.

MAHMI POLYCARBONATE ANTI-DRIP SHEET BLOCKS ULTRAVIOLET RAYS THAT BURN PLANTS AND LIVING TISSUES.

AND TRANSMITS ONLY BENEFICIAL RADIATION.

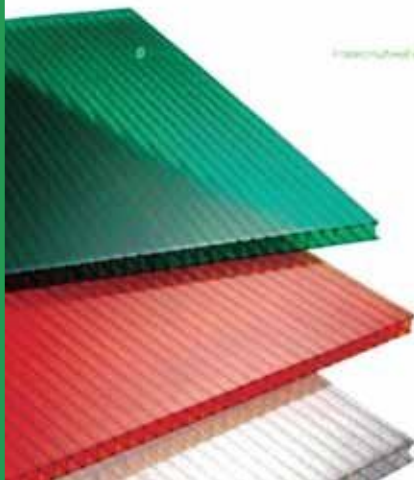

Multiwall Polycarbonate Sheet

Frosted multiwall sheets series has the features of brightness and shiny, making the penetrated light softer, which eliminates light band, decrease light pollution and provides better visual effects and abrasion resistance.

Wall	Grade name	Thickness(mm)	Weight(kg/m ²)	Rib distance (mm)	U-value (W/m ² /K)	UV UV Side	LT(%) clear	LT(%) opal
2-wall R-structure	BGL42RS45	4	0.81	4	1.96	1.2	78	47
	BGL42RS10	4.5	1.0	5	1.86	1.2	77	47
	BGL42RS11	6	1.3	6	1.76	1.2	77	46
	BGL42RS15	8	1.9	10	1.28	1.2	76	44
	BGL42RS17	10	2.7	16	1.02	1.2	75	44



موزعون لرقائق البولي ايثلين التي تصنع حسب المواصفات والمقاييس الاوربية وقد اثبتت منتجاتها مقاومة عالية لدرجات الحرارة والرطوبة العالية

Heat & Humidity Resistant Polyethylene Foils According to European Standards



PRODUCT DATA SHEET

PRODUCER	Mahmi by HiTEC	
PRODUCT TYPE	UV2982AD	
PRODUCT DESCRIPTION	3-LAYER, LONG-LIFE, COLORLESS, HIGH DIFFUSING, ANTI-DRIPPING GREENHOUSE FILM	
RESINS	LDPE/LLDPE	
NOMINAL THICKNESS (mic)	200	
AVERAGE THICKNESS TOLERANCE	± 5% ON NOMINAL THICKNESS	
MECHANICAL PROPERTIES	TEST METHOD	TYPICAL VALUES
TENSILE STRENGTH @ BREAK (MPa)	ASTM D882	
-MACHINE DIRECTION		25
-TRANSVERSAL DIRECTION		25
ELONGATION @ BREAK (%)	ASTM D882	
-MACHINE DIRECTION		600
-TRANSVERSAL DIRECTION		700
TEAR RESISTANCE (gf/ mic)	ASTM D1922	10.0
DART DROP (g)	ASTM D1709	600
OPTICAL PROPERTIES		
LIGHT TRANSMISSION (%) (400-700 nm)	TN2155-5	≥ 88
DIFFUSION (%) (400-700 nm)	TN2155-9	70-72



موزعون لرقائق الشبك واغطية التظليل ماركة التي تصنع حسب المواصفات
والمقاييس الاوربية وقد اثبتت منتجاتها مقاومة
عالية لدرجات الحرارة والرطوبة العالية

Heat & Humidity Resistant Shading Net Foils

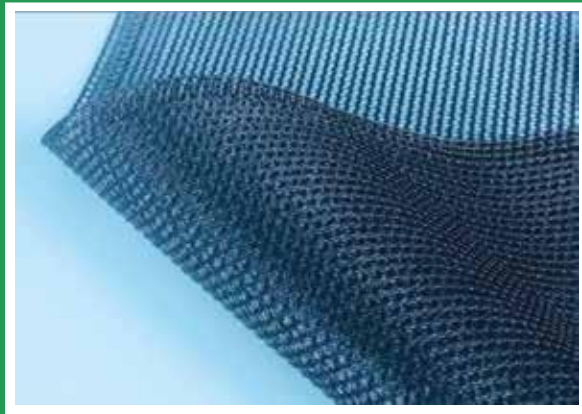

لعملية تركيب الاغطية الخاصة بالبيوت الزراعية يتوفر لدينا
ونستخدم أفضل الاكسسوارات والمعدات اللازمة لذلك الغرض

High Quality Greenhouse Covers Installation And Engineering

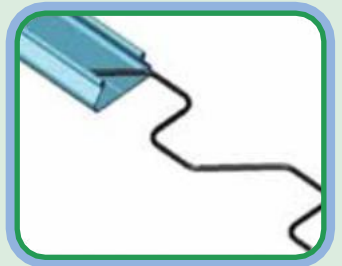
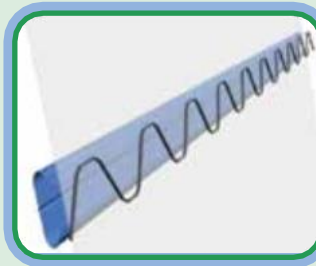
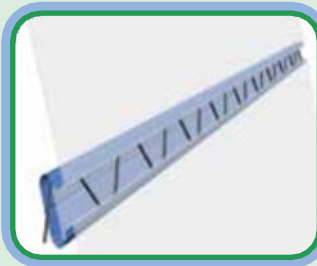
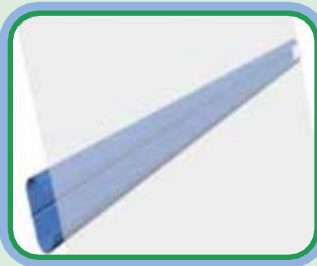
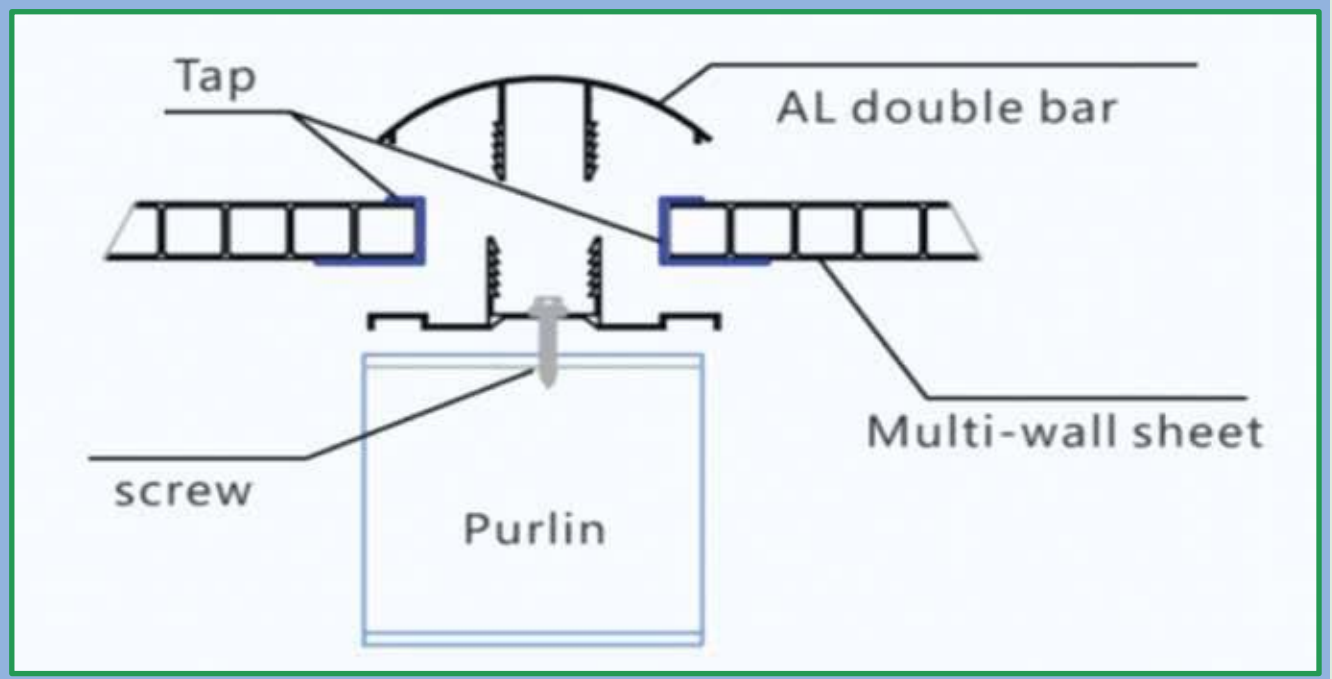

مراوح التبريد ذات الجودة العالية والخاصة بالبيوت الزراعية بكافة أنواعها ومقاساتها Mahmi Greenhouse Cooling Fans

MSC-CENTRIFUGAL EXHAUST FAN



[Structure and principle]

MSC - High Class Fan is composed of a blade, motor, outer frame protecting ribs and supporting frames and shutters. The shutters are opened by the Push-out Control System. The major parts are made of galvanized steel sheets (16kg/27kg/m²) and cooling-resistant stainless steel sheets. Based on sound aerodynamic principle, wind resistance is minimized and efficient airflow is achieved. All products are used in a wide range of settings, including various types of farms, greenhouses and factory buildings.

[Application examples]

[Technical parameters]

Model specifications	Diameter (mm)	Blade material and size	Max. output (m ³ /min)	Air flow (m ³ /hr)	2nd Total pressure (mmHg)	Noise (dB(A))	AW Input power (kW)	220 Rated voltage (V)	Motor Height (mm)	Motor Width (mm)	Motor Thickness (mm)
MSC-800	710 (28")	650	1400	18000	80	< 70	370	380	800	900	450
MSC-1000	910 (36")	650	1400	29000	80	< 70	350	380	1000	1000	450
MSC-1100	1000 (40")	600	1400	33000	70	< 70	750	380	1100	1100	450
MSC-1220	1100 (43")	480	1400	39000	50	< 70	1100	380	1220	1220	450
MSC-1380	1270 (50")	480	1400	43000	50	< 70	1100	380	1380	1380	450
MSC-1530	1400 (55")	420	1400	51000	50	< 75	1500	380	1530	1530	450

[Performance characteristics]

- Fan Blade:** composed of 6-blade stainless steel, made by punch forming, ensuring no dust, attractive and durable. The special blade shape design ensures large air volume, no deformation and a continuous, consistent rate of air flow.
- Motor:** both Chinese famous motor and Siemens motor are available. Motor voltage and frequency may be customized. The Chinese famous motor are especially designed for the fan, and it is the first of its kind with protection device which can prevent off during a shortage of electricity. Motor protection grade: IP55, insulation class: Class F.
- Fan Belt Pulley:** composed of high strength aluminum-magnesium alloy by die-casting which reduces the weight of the motor pulley and provides a self-cleaning, high corrosion resistance. It utilizes a special "three reinforced ribs pulley" design. Heat-treating treatment is done to provide an attractive appearance, as well as minimize external stress, improving its own rigidity and stability to remove breakage.
- Fan Bearing:** adopts imported double-row bearings with special waterproof design, ensuring water does not enter. Exhibits high strength, lower noise, is maintenance free and has a long service life.
- Control System:** opens the shutters at suitable tilt degree angle to ensure the blades or resistance when encountering an obstacle. When closed, the spring coil automatically locks tight and into the square hole, ensuring it is the first to absorb high quality, 100% water to ensure long service life. The features of the centrifugal motor are made of copper motor which can resist water spraying and has high resistance. The guide rail is made of 20# high strength, rust-resistant stainless steel which resists rust.

[Production equipment]



MSH-SERIES HEAVY HAMMER EXHAUST FAN



MSH - Fan is mainly composed of a blade, motor, outer frame protecting ribs and supporting frames and shutters. The motor drives blade to cause air flow and shutters can open and close automatically to keep the dust from entering. The major parts are made of galvanized steel sheets and stainless steel sheets.

[Technical parameters]

Model specifications	Diameter (mm)	Blade material and size	Max. output (m ³ /min)	Air flow (m ³ /hr)	2nd Total pressure (mmHg)	Noise (dB(A))	AW Input power (kW)	220 Rated voltage (V)	Motor Height (mm)	Motor Width (mm)	Motor Thickness (mm)
MSH-820	520 (21")	1400	1400	9700	55	< 80	370	380	620	620	370
MSH-930	710 (28")	650	1400	18000	75	< 80	370	380	800	900	400
MSH-900	750 (30")	650	1400	20000	60	< 80	580	380	900	900	400
MSH-1000	900 (36")	610	1400	23000	70	< 80	580	380	1000	1000	400
MSH-1100	1000 (40")	600	1400	27000	70	< 80	730	380	1100	1100	400
MSH-1220	1100 (43")	480	1400	38000	70	< 80	1100	380	1220	1220	400
MSH-1380	1250 (50")	430	1400	44000	60	< 80	1100	380	1380	1380	400
MSH-1530	1400 (55")	430	1400	53800	60	< 80	1500	380	1530	1530	400

- Fan Blade:** composed of 6-blade stainless steel, made by punch forming, ensuring no dust, attractive and durable. The special blade shape design ensures large air volume, no deformation and a continuous, consistent rate of air flow.
- Motor:** both Chinese famous motor and Siemens motor are available. Motor voltage and frequency may be customized. The Chinese famous motor are especially designed for the fan, and it is the first of its kind with protection device which can prevent off during a shortage of electricity. Motor protection grade: IP55, insulation class: Class F.
- Fan Belt Pulley:** composed of high strength aluminum-magnesium alloy by die-casting which reduces the weight of the motor pulley and provides a self-cleaning, high corrosion resistance. It utilizes a special "three reinforced ribs pulley" design. Heat-treating treatment is done to provide an attractive appearance, as well as minimize external stress, improving its own rigidity and stability to remove breakage.
- Fan Bearing:** adopts imported double-row bearings with special waterproof design, ensuring water does not enter. Exhibits high strength, lower noise, is maintenance free and has a long service life.
- Drop Hammer:** using high strength spring, this spring drop hammer opening device ensures the flexibility of the opening and closing of the shutters.
- Roller:** imported balls that can't be long service life, ensuring optimal maintenance.



مراوح التبريد ذات الجودة العالية والخاصة بالبيوت
لزراعية بكافة أنواعها ومقاساتها

Mahmi Circulation Fans For All Greenhouse Types

MAHMI SERIES CIRCULATION FAN



[Performance characteristics] :

- ◆ Features the excellent "Haier" brand electronics.
- ◆ International advanced energy conservation technology tested.
- ◆ Light aluminum board punch press fan blazer: exhibits a wide angle, large air pressure and low noise.
- ◆ Outer covering is stainless steel. Steel spraying is also available.
- ◆ Equipped with beautiful and convenient button type hanging articles.
- ◆ Long service life: over 10 years.

[Technical parameters] :

Type	Diameter blades	AirVolume	Power	Voltage	motor rotation	HZ
MS -300	300	2880	150	220 (380)	1400	50
MS -400	400	4180	250	220 (380)	1400	50
MS -500	500	5300	250	220 (380)	1400	50
MS -600	600	6500	370	220 (380)	1400	50





شركة محمي تقوم بتصميم وتصنيع وتوريد أنظمة التحكم بالتسميد
والري والطقس وذلك بما يتناسب مع متطلبات كل مزرعة
**Specialized Designing And Engineering of Fertilization,
Irrigation And Environment Control Systems**



لمحة عن زبائننا ومشاريعنا

1. المزرعة رقم ٢٥٤: توريد وتركيب 41 بيت زراعي مبرد مساحة ١٠٨٨ متر مربع لكل وحدة بمساحة إجمالية ٤٤٦٠٨ متر مربع.
2. المزرعة رقم : ٢٥٤ اثنان من البيوت الزراعية الشبكية ٩١٠٠ + ٩٩٨٤ متر مربع
3. مزرعة الوبرة : بيت زراعي شبكي واحد بمساحة ٩١٠٠ متر مربع توريد فقط
4. مزرعة الشيخ عبد الله بن ناصر بيت زراعي مبرد بمساحة ١٠٨٠ متر مربع
5. المزرعة رقم ٢٥٤: توريد وتركيب غرفة تجفيف تمور مساحة ٧٦ متر مربع
6. شركة غراس للتجارة والزراعة (نباتي) : توريد ١٣٠٠٠٠٠ حقيبة الباف جوز الهند مغسول بمياه الأمطار الحجم: 29 لتر الحجم الموسع : (16 * 18 * 100) سم التركيب : 70% كوكو و 30% رقائق , معبنة في أكياس معالجة بالأشعة فوق البنفسجية .
7. شركة جنة الزراعية : توريد مراوح عدد (1820) مروحة والواح تبريد عدد (7540) لوح .
8. شركة جنة الزراعية : توريد لوحات تحكم كهربائية للبيوت الزراعية عدد (250) لوحة .
9. توريد وتركيب 62 محط معالجة مياه ابار لمزارع مختلفة في قطر .
10. شركة قطفة : توريد لوحات تحكم كهربائية وأسلاك تعليق ومواد تركيب وتجميع بيوت زراعية .
11. شركة غراس للتجارة والزراعة (نباتي) : توريد شبك تظليل والواح بولي إيثيلين ومواد تركيب بيوت زراعية .
12. توريد بيوت تجفيف تمر عدد 100 الى شركة قطرات (المقاول الرئيسي لمشروع وزارة البلدية)
13. تصميم وتصنيع وتركيب 9 صوب شبك إجمالي (93000) م 2 لشركة الريان الزراعية
14. تصميم وتصنيع وتوريد ثلاث بيوت زراعية مبردة لشركة ربوع الياسمين في المملكة العربية السعودية بمساحة إجمالية 19,000 متر مربع

An overview of our clients and projects :

1. Farm No. (254) two net houses (9100 + 9984 square meters).
2. Farm No. (254) supplying and installing 41 cooled greenhouses units with an area of 1,088 square meters for each unit, and a total area of 44,608 square meters
3. Al Wabra Farm: One net house with an area of 9,100 square meters. Supply only.
4. The farm of Sheikh Abdullah bin Nasser, a cooled greenhouse, with an area of 1080 square meters.
5. Farm No. (254) installed room for drying dates, an area of 76 square meters.
6. Gheras Trading and Agricultural Services Company (Nabati): Supplying 130000□Coco Peat Grow Bags with rainwater Volume: 29 liters Expanded volume: (100 * 18 * 16) cm Composition: 70% coco and 30% chips, packed in UV-treated bags.
7. Jannah Agricultural Company: Supplying (1820) fans and cooling panels (7540) Pcs.
8. Jannah Agricultural Company: Supplying (250) sets of electrical control panels for the greenhouse.
9. Supply and installation of 62 RO system – water treatment plant- for various farms in Qatar.
10. Qatfa Company: Supplying electrical control panels, suspension wires, and installation materials for the greenhouse.
11. Gheras Trading and Agricultural Services Company (Nabati): Supplies shading nets, polyethylene sheets, and greenhouse installation materials.
12. Supply of 100 dates drying houses to Qatarat Company (the main contractor for the project of the Ministry of Municipality)
13. Design, manufactured, and installation of 9 net greenhouses in total (93000)m2 for AL Rayyan Agricultural
14. Design, manufacture and supply Three cooling greenhouses for Raboua Al Yasmeen Company in KSA With a total area of 19,000 square meters





Specialty Electronic Materials Switzerland GmbH
Grossmatte 4,
CH-6014 Luzern
Switzerland



Date: 20/07/2023

To Whom It May Concern

We hereby confirm that **Mahmi Agricultural Trading**, located at Mashaal Street 400-Zone 56 - Doha- Qatar are our authorized dealer to offer, market, sell and handle the after sales services for our FILMTEC™ Membrane products in Qatar. Moreover, we provide them complete technical solutions for any online troubleshooting or arranging specialist at site.

This is to confirm that **Specialty Electronic Materials Switzerland GmbH** and **Filmtec Corporation** are indirectly owned subsidiaries of the **DuPont de Nemours, Inc.**

Should you have any further questions, please do not hesitate to write to us.

Yours faithfully,

Best Regards

Sanjeev Unni

Regional Commercial Manger, Middle East & Africa





Water Solutions



FilmTec™ SW30XFR-400/34 Fouling Resistant Element



Longstanding legacy in step-change innovation



Longer storage time



No need to check conditions of preservation solution



Improved sustainability footprint



Reliable high quality and extended product warranties



Easier inventory and warehouse management



Safer installation due to 4kg reduction in weight and ease of handling





Mahmi

Mahmi

for water solutions & greenhouse



+974 7750 7722

+974 4450 7722

info@mahmi.net

<https://www.facebook.com/MahmiGlobal>

<https://www.instagram.com/mahmiglobal>

www.mahmi.net

Al Zubarah Petrol Station - zone 76 - Street 253, Building 4199
North Road Rawdat Al Faras - Qatar